

**DATA-INFO**

**# 49.150**

**Dataflex®**  
is a registered  
trademark of  
VIKING A.C. EUROPE BV  
P.O. Box 713  
NL-2920 CA  
Krimpen a/d IJssel

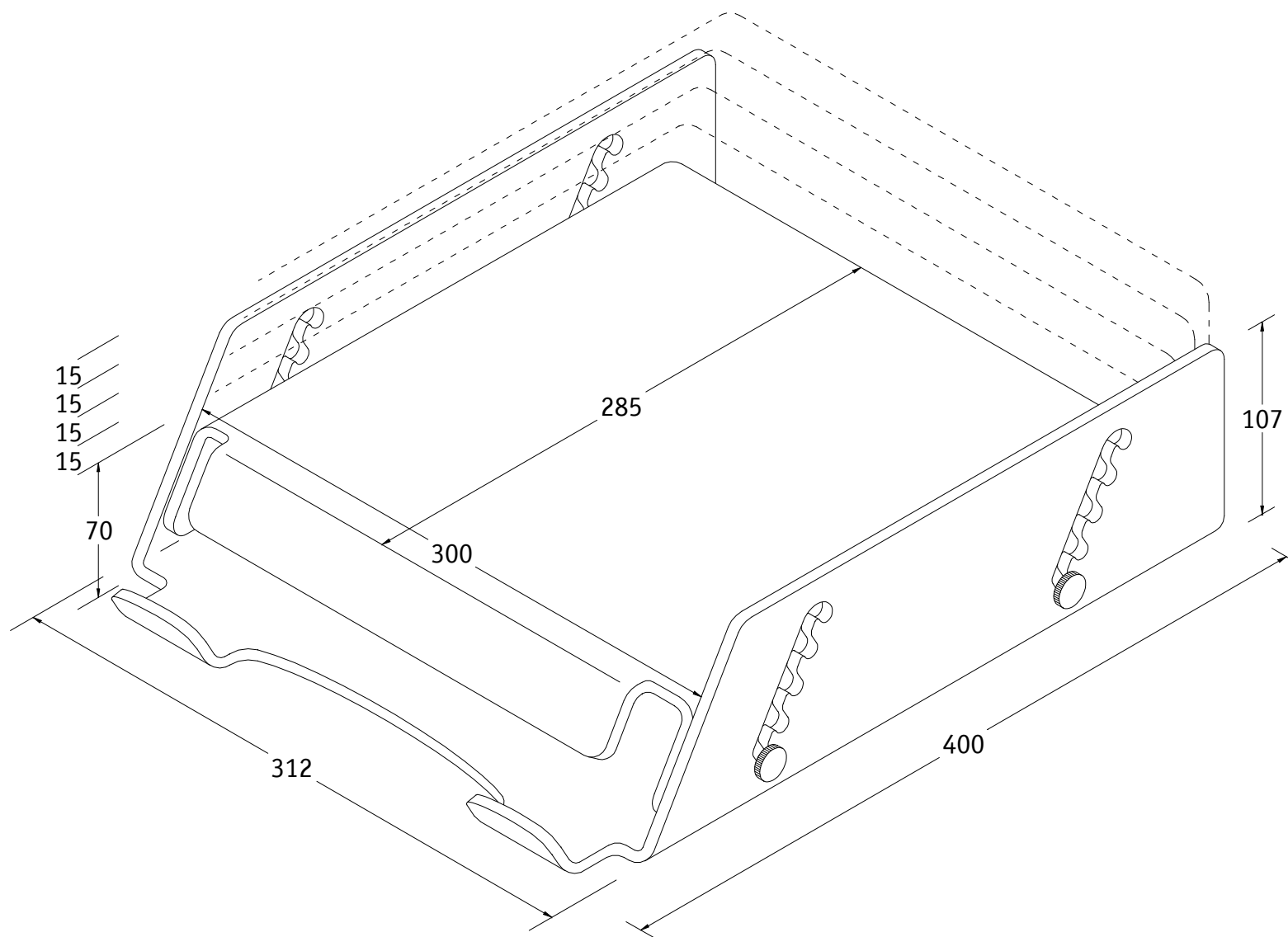

All dimensions in mm.