

**DATA-INFO**

**# 49.480**

**Dataflex®**  
is a registered  
trademark of  
DATAFLEX  
INTERNATIONAL BV  
P.O. Box 713  
NL-2920 CA  
Krimpen a/d IJssel

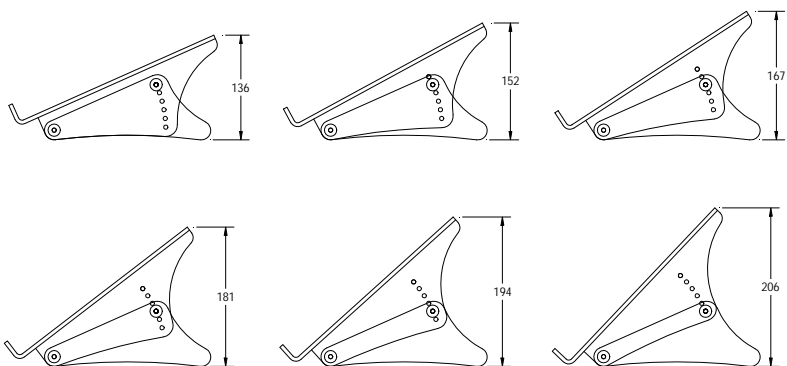
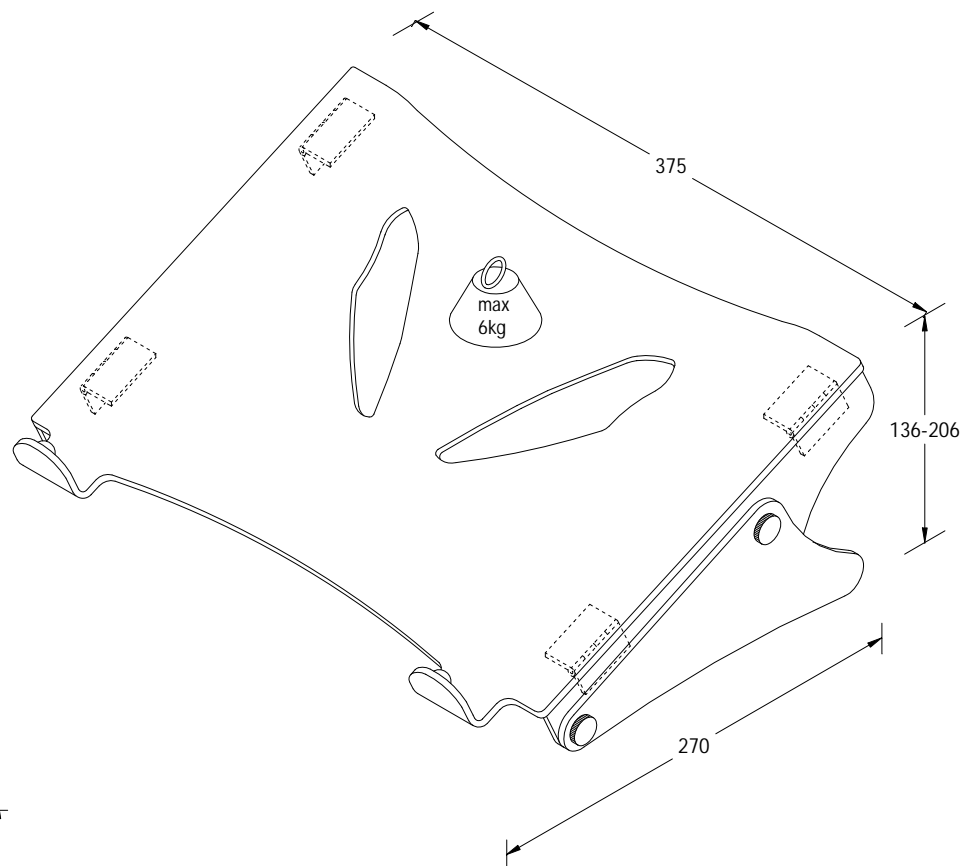

All dimensions in mm - Dimensions en mm - Abmessungen in mm - Alle afmetingen in mm