

**DATA-INFO**

**# 51.952**

**Dataflex**<sup>®</sup>  
is a registered  
trademark of  
VIKING A.C. EUROPE BV  
P.O. Box 713  
NL-2920 CA  
Krimpen a/d IJssel

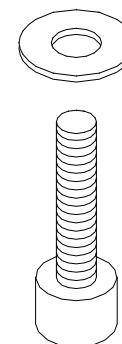
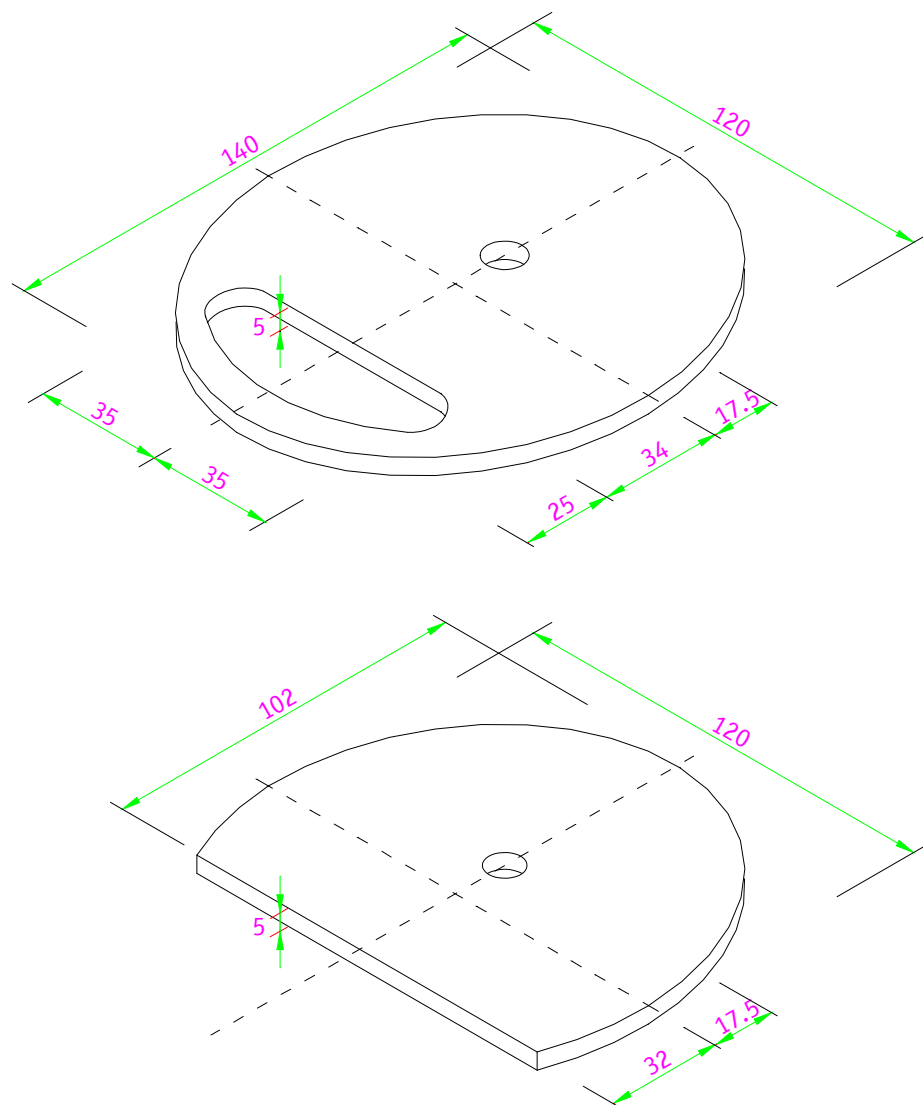

All dimensions in mm.