

DATA-INFO
61.120/3

Dataflex®
is a registered
trademark of
VIKING A.C. EUROPE BV
P.O. Box 713
NL-2920 CA
Krimpen a/d IJssel

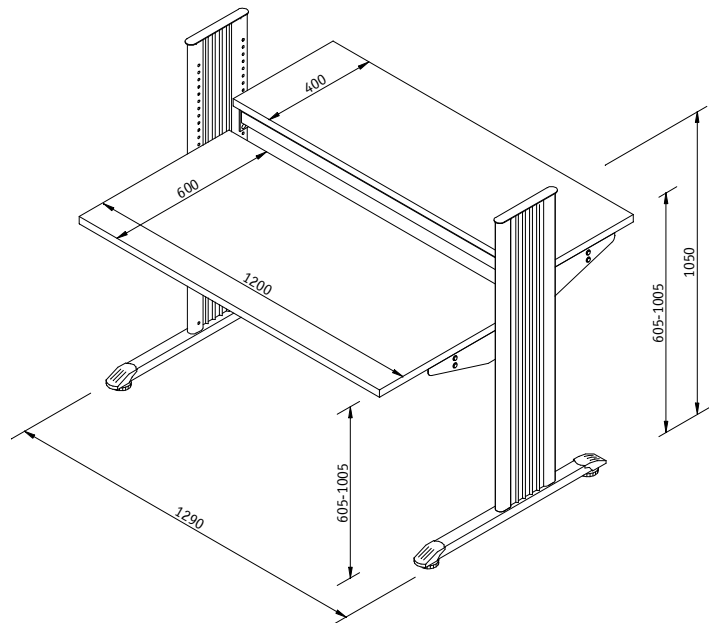

Split version

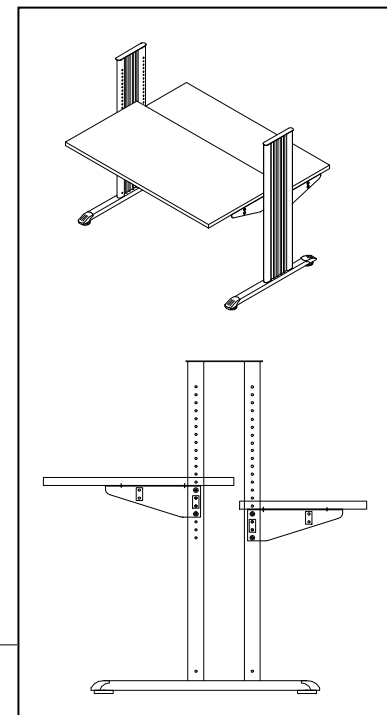
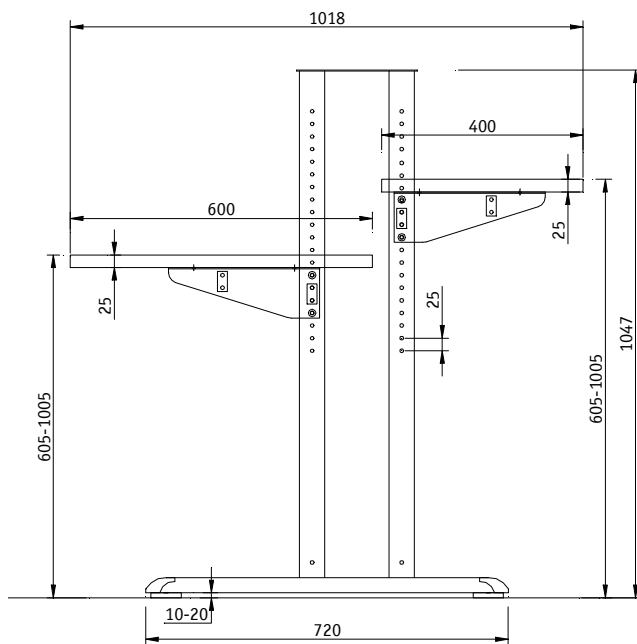

In line version

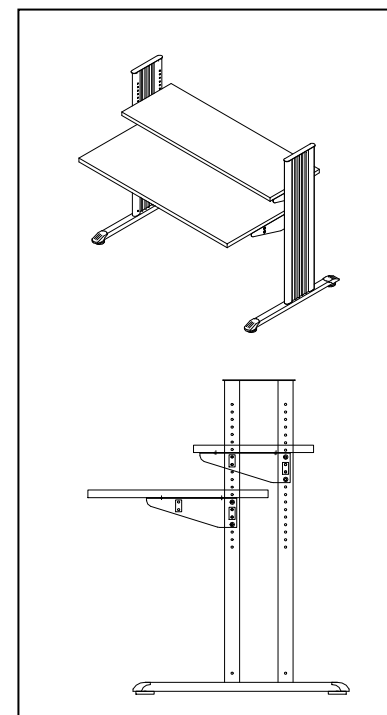
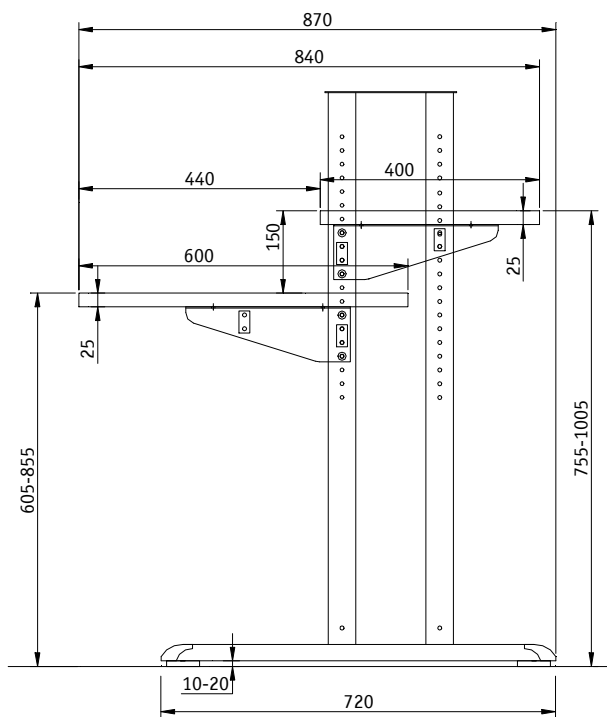
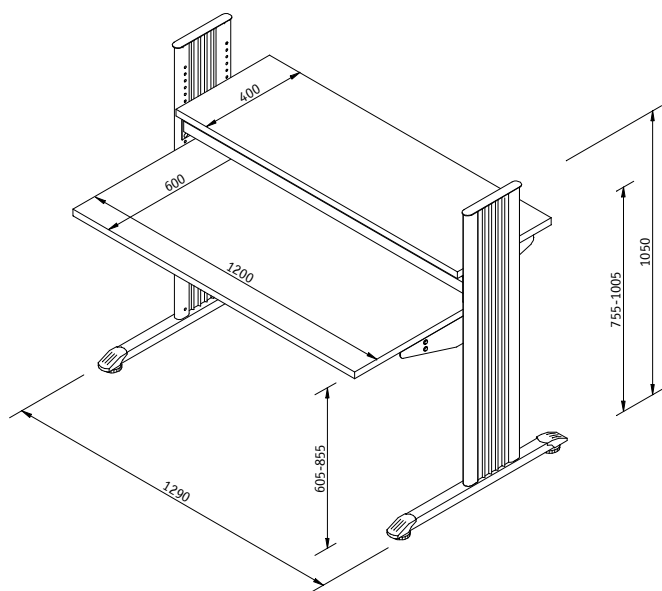

All dimensions in mm.