

52.112

## Viewmate toolbar - desk 112

This adjustable ergonomic toolbar was made to be very sturdy, yet stylish and affordable. Combine the various products within the Viewmate toolbar range to free up desktop space and make any workplace neatly organised and a lot more practical.

- Toolbar assembly with a rail length of 1200 mm
- Comes with a desk clamp mount and bolt-through desk mount
- Suitable for a desktop thickness of 5 up to 40 (clamp) or 50 mm (bolt through)
- Pole height 400 mm
- Pole diameter 38 mm

# viewmate <sup>x</sup>

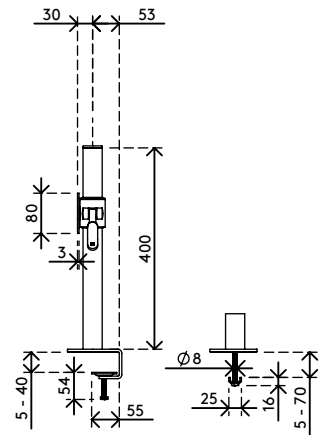
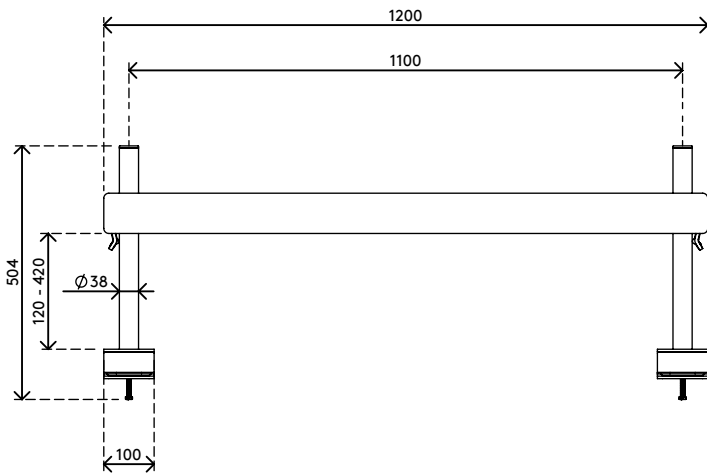
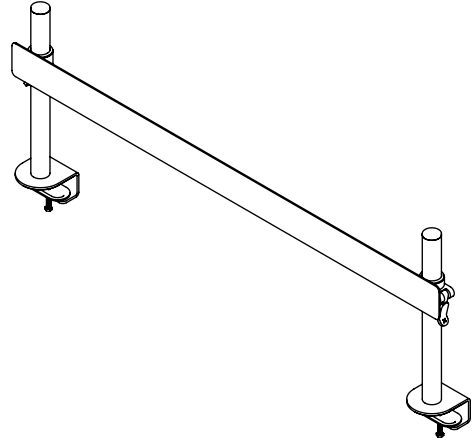
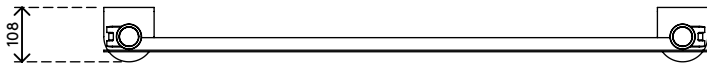

Viewmate toolbar - desk 112

2017/05/08

# 52.112

 1240 x 210 x 130 mm

 1 pcs

 silver

 9,1 kg

 805410521127